MED64

The most sensitive microelectrode array system
for *in vitro* extracellular electrophysiology

Product Manual

MED Duet Connector

P/N: MED-C05



ALPHA MED SCIENTIFIC

Information in this document is subject to change without notice.No part of this document may be reproduced or transmitted without the expressed written permission of Alpha MED Scientific Inc.

While every precaution has been taken in the preparation of this document, the publisher and the authors assume no responsibility for errors or omissions, or for damages resulting from the use of information contained in this document or from the use of programs and source code that may accompany it. In no event shall the publisher and the author be liable for any loss of profit or any other commercial damage caused or alleged to have been caused directly or indirectly by this document.

© 2021 Alpha MED Scientific Inc. All rights reserved.

Version: 1.00; April 5, 2021

Alpha MED Scientific Inc.

Saito Bio-Incubator 209, 7-7-15, Saito-asagi,

Ibaraki, Osaka 567-0085, Japan

E-mail: support@med64.com

Website: <http://www.med64.com>

Contents

1. MED Duet Connector Components and Functions	1
1-1. Components and their functions	2
Setting up	2
Accessories	4
2. Installation	5
2-1. Connecting the MED Duet Connector to the MED64 Head Amplifier	5
2-2. Orientation for the electrodes and terminal assignment	7
Orientation of the electrodes for each Top Unit	7
Terminal assignment.....	7
3. Installation for use	8
3-1. Installing the MED Probe 16 onto the MED Duet Connector	8
Grounding the additional ref. electrode (platinum wire)	8
Thermal conduction sheet	9
4. Troubleshoot	10
5. Maintenance	11
5-1. Cleaning of the contact pins.....	11
5-2. Sterilization	11
5-3. Storage.....	12
6. Precautions	13
7. Warranty	13
8. Specifications	14

Contents

1. MED Duet Connector Components and Functions

The MED Duet Connector (MED-C05) is a Connector for the MED64-Quad II System. It connects two MED Probe 16 to the MED64 Head Amplifier (MED-A64HE1S) allowing recording extracellular signals at 16 micro planar electrodes embedded in the MED Probe 16.

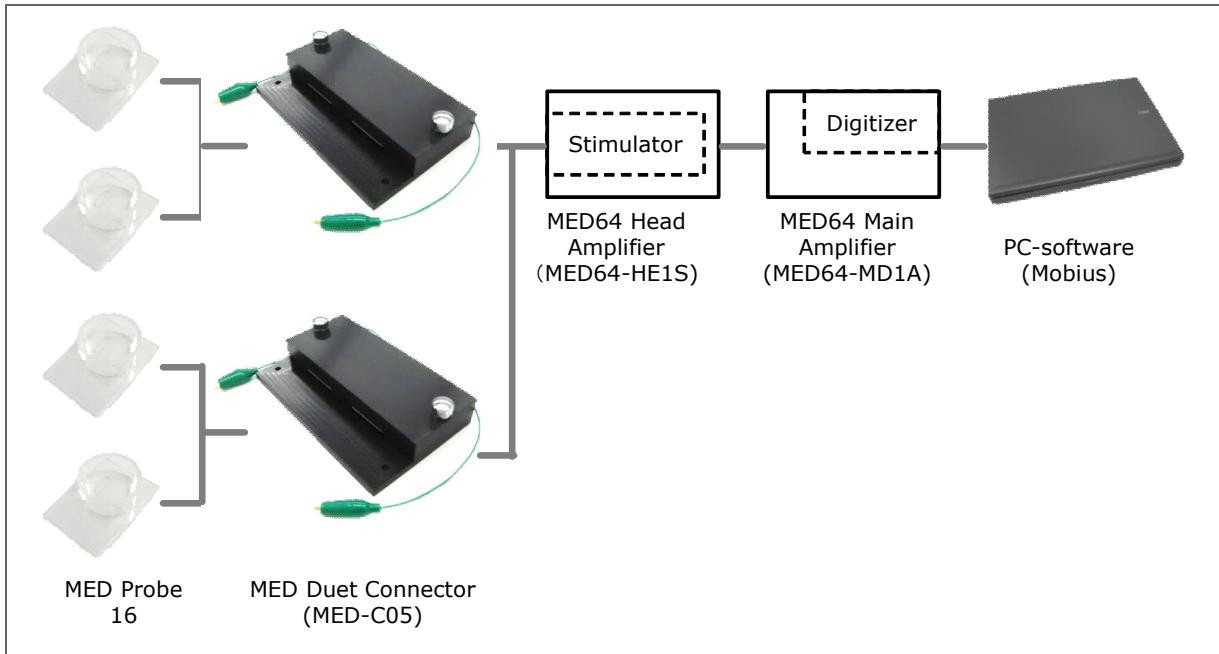

Figure 1. System diagram for the MED64-Quad II System.

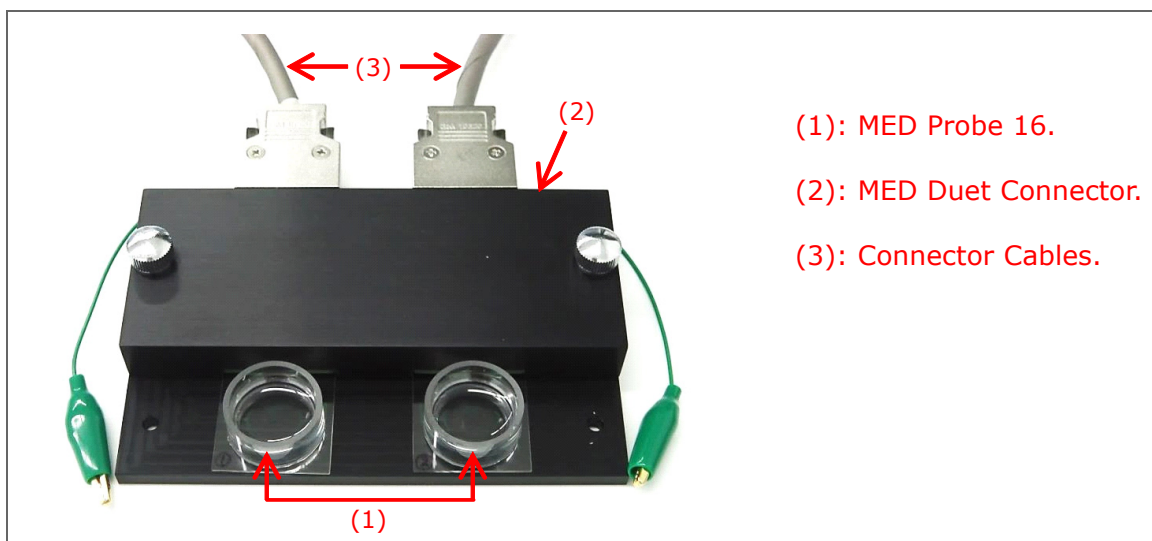

Figure 2. MED Duet Connector with two MED Probe 16.

1-1. Components and their functions

MED Duet Connector consists of 1 Base Unit and 2 kinds of Top Unit. Each Top Unit should be used for 2x8 MED Probe16 (Type: D) or 4x4 MED Probe 16 (Type: B).

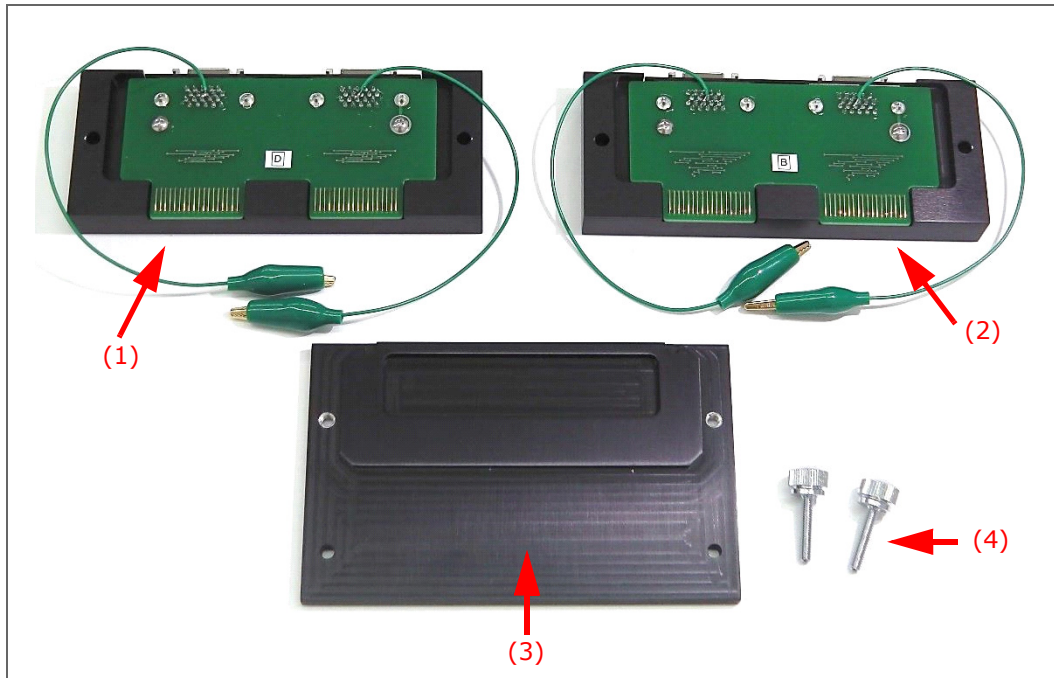

Figure 3. MED Duet Connector's components.

- (1) Top Unit -D type-:
For 2x8 type MED Probe 16 (PG/RG-515A).
- (2) Top Unit -B type-:
For 4x4 type MED Probe 16(PG/RG-501A).
- (3) Base Unit:
To place and fix the Top Unit. Insert MED Probe16 into the slit between the Top Unit and the Base Unit.
- (4) Fixing Screws (2):
To fix the Top Unit to the Bottom Unit.

Setting up

To set up the MED Duet Connector, select the Top Unit according to the MED Probe 16. Put the Top Unit on the Base Unit and fix them with the Fixing Screws (Figure 4).



Figure 4. Setting up of the MED Duet Connector. Just putting the Top Unit on the Bottom Unit and fixing with the Fixing Screws.

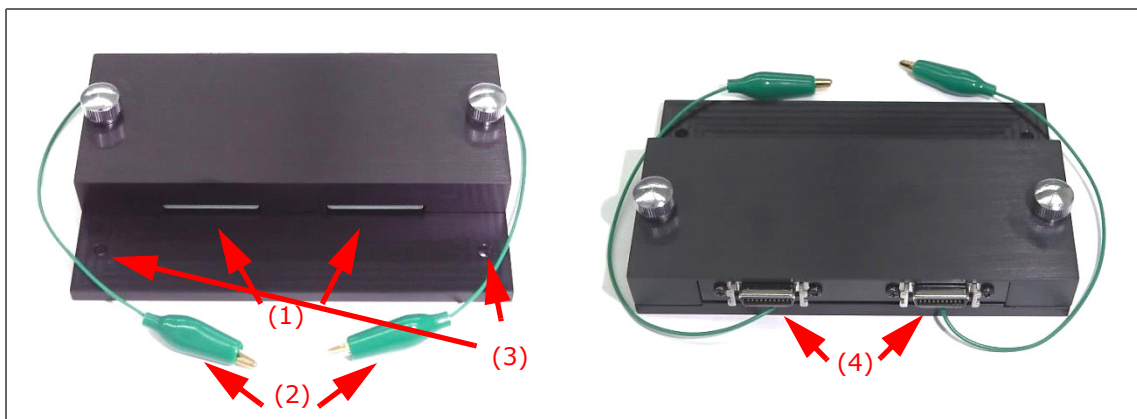

Figure 5. Front view (left) and back view (right) of MED Duet Connector.

- (1) MED Probe port:
Insert the MED Probe 16 here.
- (2) Ground wire:
Ground the additional ref. electrode here when additional ref. electrode (e.g. platinum wire in the Perfusion Cap) is used.
- (3) Guide hole:
Those holes are used when the MED Duet Connector is installed onto the ThermoBase.
- (4) 20-pin output terminal:
Connect the MED Connector Cable (20 pin) here.

Accessories

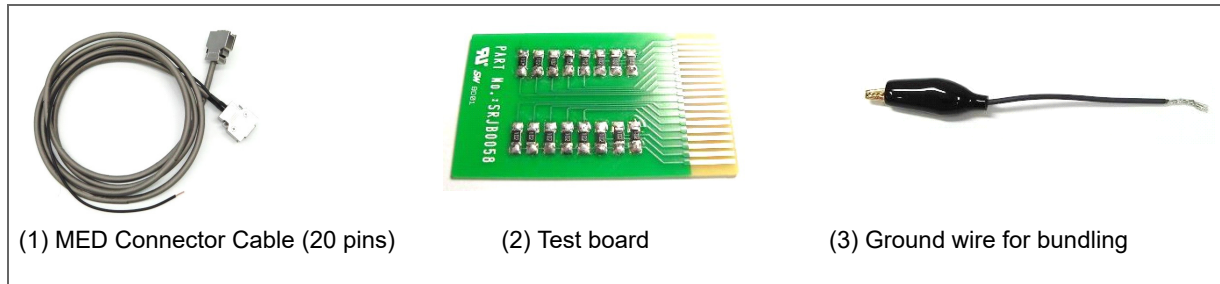

Figure 6. Accessories for the MED Duet Connector.

- (1) MED Connector Cable (20 pin)(2):
Connect the 20 pin output terminal to the INPUT 1-16CH, 17-32CH, 33-48Ch, 49-64CH in the MED64 Head Amplifier (MED-A64HE1S). The one side has a ground wire.
- (2) Test board (2):
Install in the Probe port. Use it to check the MED64-Quad II System is working appropriately.
- (3) Ground wire for bundling:
Each MED Connector Cable has ground wire. This Ground wire for bundling is used for bundling the ground wires that are attached to the MED Connector Cables.

2. Installation

2-1. Connecting the MED Duet Connector to the MED64 Head Amplifier

- Please read product manuals for all components and Operating instruction for the MED64-Quad II System as well for installation of the MED64-Quad II System.
1. Place the MED Duet Connector on a stable table and AWAY from any equipment which generates an electric or magnetic field (e.g. power supply unit, peristaltic pump, heater).
 2. Connect the 20 pin output terminals of the MED Duet Connectors to either of the INPUT 1-16CH, 17-32CH, 33-48CH, 49-64 terminal in the MED64 Head Amplifier (MED-64HE1S) with the MED Connector Cables (20 pin). Connect the side which has the ground wire to the MED Head Amplifier.
 3. Place all cables AWAY from any equipment which generates electric or magnetic field.
 - The MED Connector cable is very sensitive to noise and vibration. Make sure that the cable stays away from any equipment which generates electric or magnetic field, and sits flat on a table.
 4. Connect the Ground wire attached to the Connector cable to the SIGNAL GND in the MED64 Head Amplifier (MED-A64HE1S).
 - Let the ground wires for all Connectors go THROUGH the hole at the GND (Figure 9, top-left) to secure the grounding. If this cannot be made, use the short grounding wire (Figure 9, bottom left) to ground the all cables (Figure 9, right).

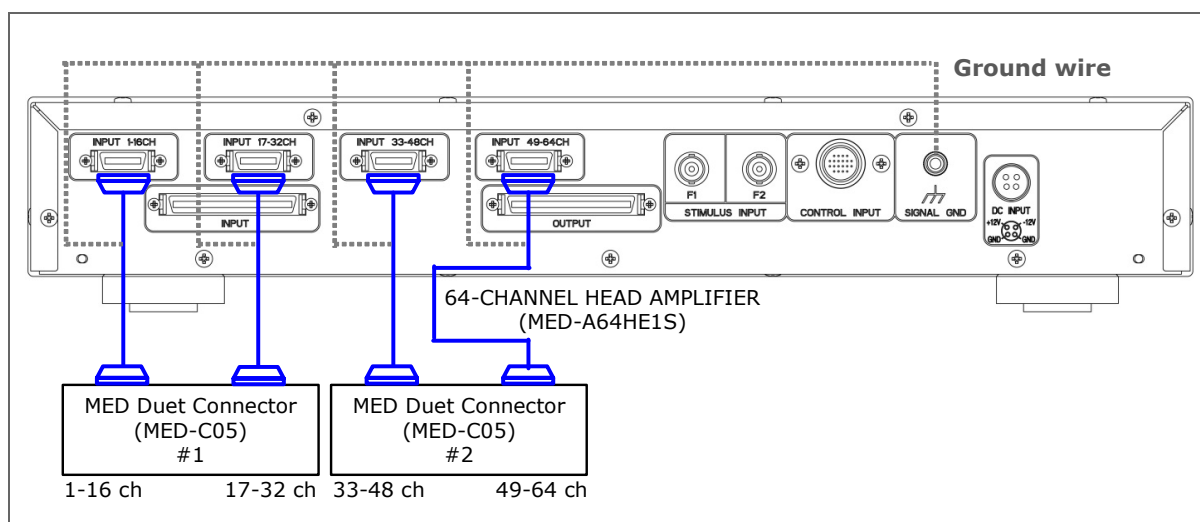

Figure 7. Connection of the MED Duet Connectors to the MED64 Head Amplifier .

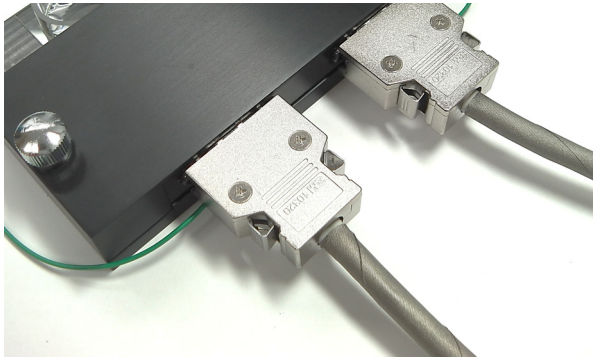

Figure 8. Connecting the MED Connector cables (20 pin) to the 20 pin output terminals.

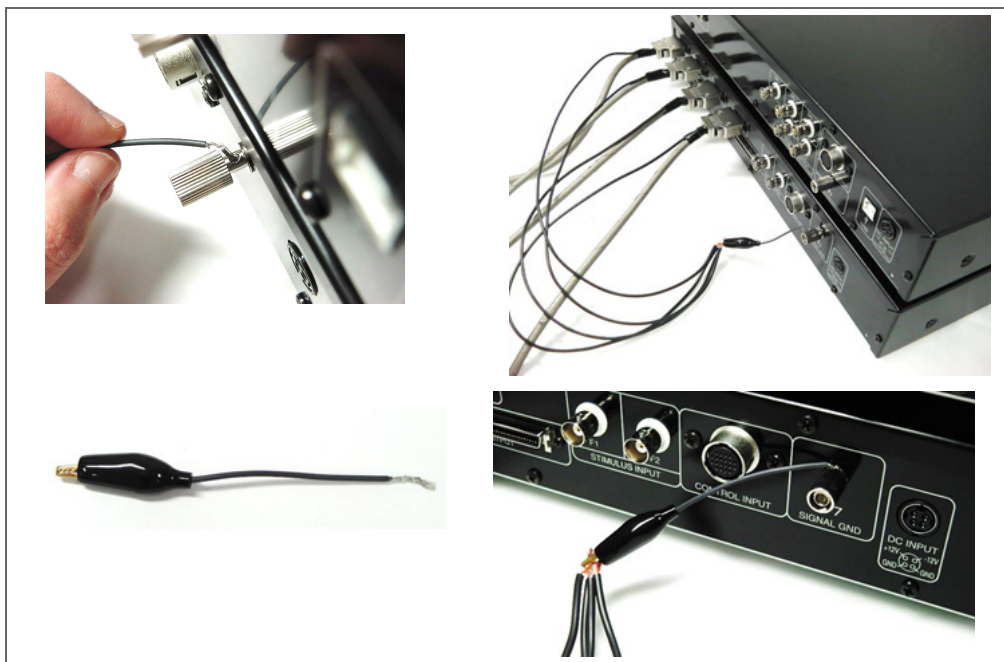

Figure 9. Grounding the Connector cables to the GND terminal in the MED64 Head Amplifier.

5. Insert the Test board to the MED Probe port for noise check. If noise will appear, check the environment around MED64 Amplifiers, Connector Cables, and MED Duet Connector.(See page-10.)

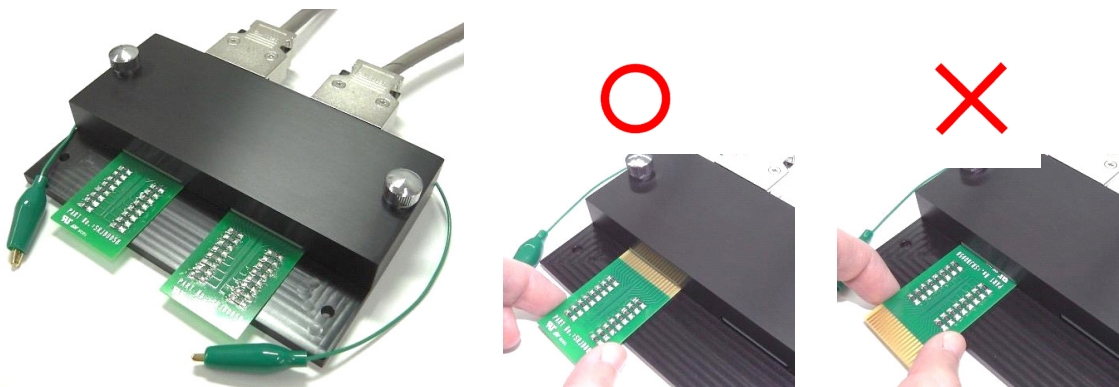

Figure 10. Insert the Test board.

2-2. Orientation for the electrodes and terminal assignment

Orientation of the electrodes for each Top Unit

As mentioned previously, MED Duet Connector has 2 types of Top Units. Each of them corresponds to 2 types of MED Probe 16. The channel assignments in a Top Connector as seen in the Figure 11 and 12.

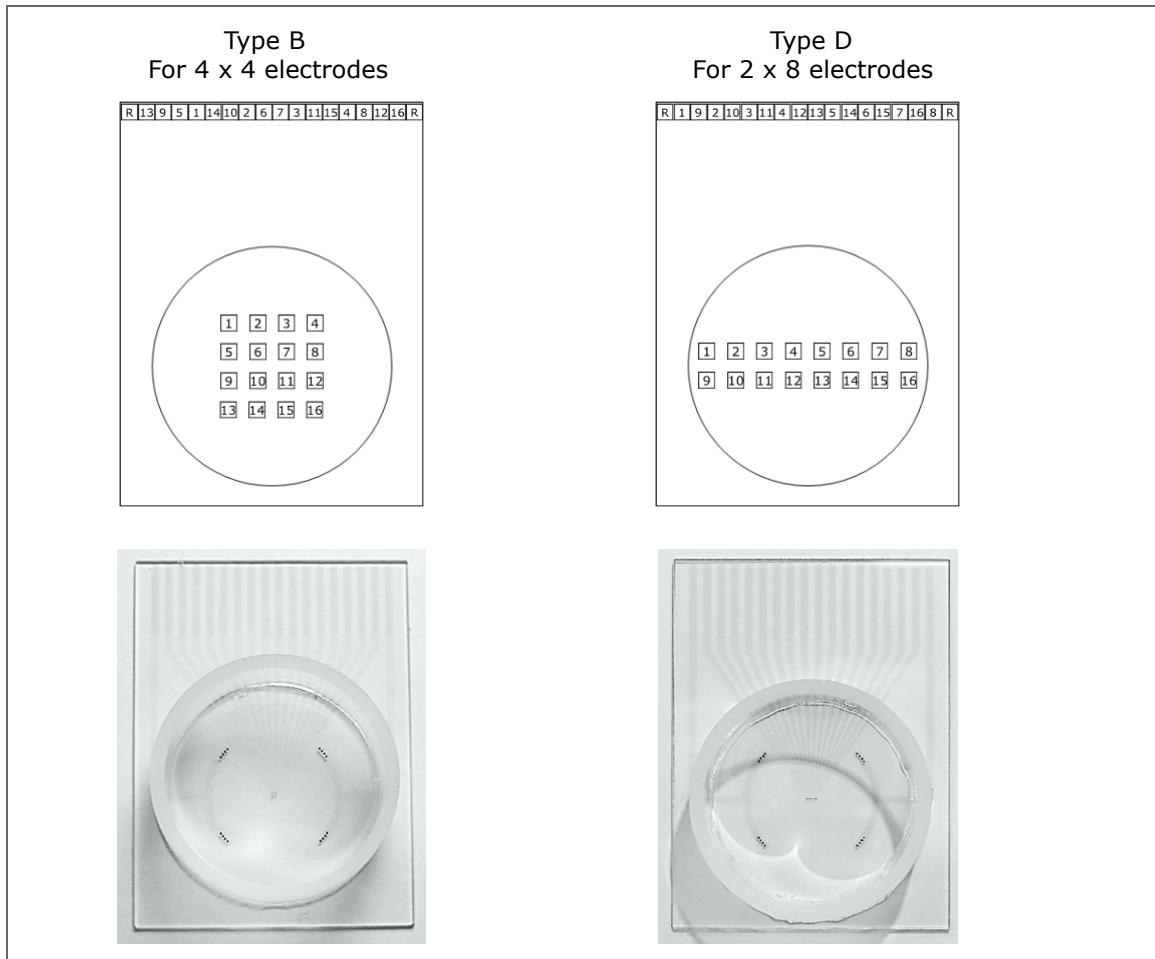

Figure 11. Electrodes orientation for each Top Unit.

Terminal assignment

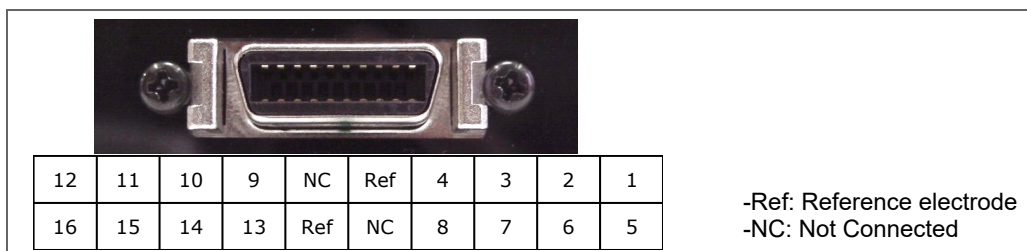

Figure 12. Terminal assignment for the MED Duet Connector.

3. Instruction for use

3-1. Installing the MED Probe 16 onto the MED Duet Connector

1. Clean the MED Probe 16 with kimwipe before loading (Figure 13, middle). If the MED Probe 16 is taken out of a humidified incubator, be sure to clean it with a kimwipe soaked with 70% ethanol.
 - The leads in the MED Probe 16 contact the gold pins in the MED Duet Connector. (Refer to Figure 13 in the page 8) Salt residue buildup (or even finger prints) in the leads can rust the contact pins.
2. Insert the MED Probe 16 into the MED Duet Connector firmly, until you feel it click into place.

CAUTION:

- Spilling liquid onto the pins will cause rust and adversely affect conduction. Be extremely careful not to get the pins wet, especially with saline solution.



Figure 13. Terminal for the MED Probe 16 (left, marked with blue), cleaning its terminal (middle), and installing the MED Probe 16 onto the MED Duet Connector (right).

Grounding the additional ref. electrode (platinum wire)

When additional ref. electrode (platinum wire) is used (e.g. platinum wire in the Perfusion Cap), make sure to ground it to the MED Duet Connector with the green ground wire. Otherwise, large noise will be introduced.



Figure 14. Grounding the additional ref. electrode (platinum wire) incorporated in the Perfusion cap.

Thermal conduction sheet

When used in combination with ThermoBase (MED-CPB01), it is recommended to install Thermal conduction sheet between MED Duet Connector and ThermoBase. The Thermal conduction sheet transmits the heat evenly to the MED Duet Connector. When the ThermoBase is purchased with MED Duet Connector at the same time, the Thermal conduction sheet will be attached.

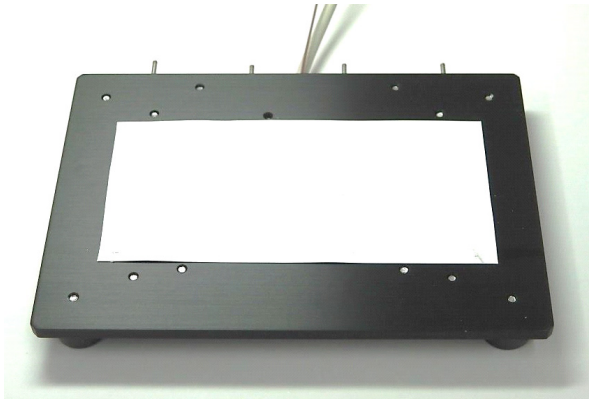

Figure 15. Thermal conduction sheet on the ThermoBase.

4. Troubleshoot

When noise appears during your experiments, it is important to identify where it comes from. Representative reasons are:

- Damaged electrodes in the MED Probes.
- Uncleaned and/or damaged contact pins in the Connector.
- Loosening of the Fixing Screws.
- Loose contacts for the cables.
- Incorrect grounding.
- Equipment that generates an electric or magnetic field (e.g. power supply, peristaltic pump, heater).
- Environment.

Poor contacts by damaged or uncleaned contact pins can cause problems such as noises or/and faulty recording. Identify this using the test board with following procedures.

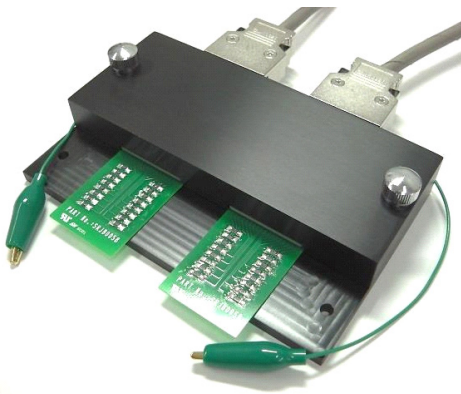

Figure 16. The Test board installed in the MED Duet Connector.

1. If noise appears at all 64 channels, the reason is likely to be in inappropriate grounding, environment, attachment between MED Probe 16 and contact pins, or amplifiers.
2. If noise is seen in specific channels, the reason is likely to be in the Connector, Connector cable, or Probes. Swap the MED Probe to a test board, and then run the MED64 Quad II System.
3. If noise is gone, the cause of the problem is the Probe.
4. If noise remains, it is likely caused by poor contacts. To see whether it is caused by poor contact with the cables, disconnect and then reconnect the Connector cables.
5. If it is NOT improved, clean the contact pins in the MED Duet Connector according to the instruction on page 11.
 - Please refer to the page 29 in the MED64 Quad II Operating Instruction, [Troubleshoot] for troubleshooting.

5. Maintenance

5-1. Cleaning of the contact pins

The 18 leads (for each recording electrode and reference electrode) in a MED Probe 16 are connected to the Connector with small contact pins. Uncleaned contact pins can cause noise or faulty recordings. Clean the gold contact pins with following procedure if dirty pins cause noise or any other problems.

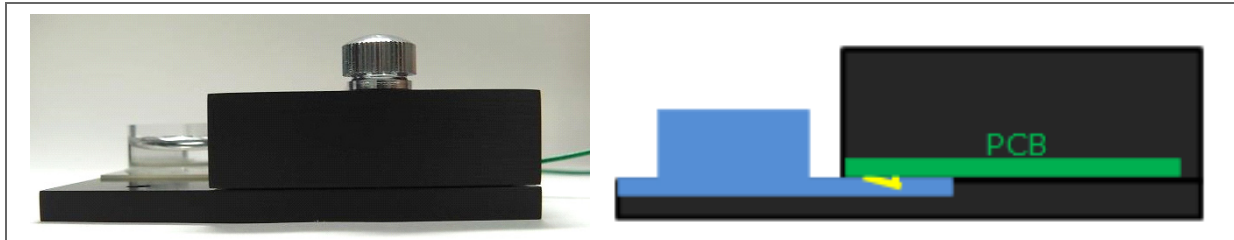

Figure 17. MED Duet Connector where the MED Probe 16 is loaded (left). View from side (left) and a schematic (right).

1. Clean the contact pins on the printed circuit board with "kimwipe soaked with 70% ethanol". Clean the contact pins, one-by-one, longitudinally. **Do NOT clean the pins laterally, which might damage the pins.** (See Figure 18.) Do not touch the contact pins with bare hands.

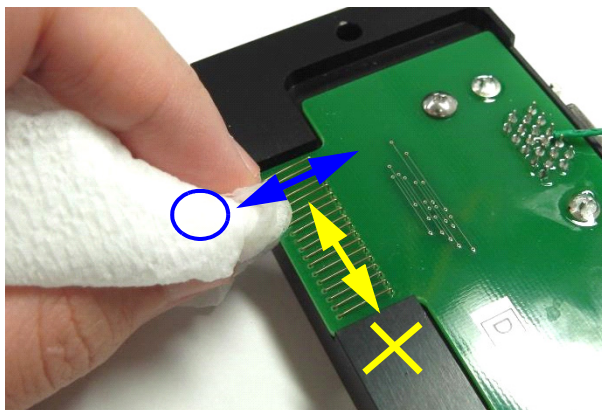

Figure 18. Cleaning the contact pins. Clean them longitudinally.

2. Re-assemble the Base unit and Connector unit.

5-2. Sterilization

Wipe it with a lint-free cloth soaked in 70% ethanol, and allow to dry.

CAUTION:

- Do NOT autoclave as it may damage the MED Duet Connector.

5-3. Storage

Store in a cool dry area. Avoid exposure to high temperatures or humidity.

6. Precautions

- DO NOT spill medium or any other liquid on the contact pins.
- DO NOT give strong mechanical shock by putting heavy material on the unit or dropping the unit.
- DO NOT touch the contact pins on the connector unit with bare hands or fingertips when they are cleaned. This may cause rust and adversely affect conduction.

What should I do if medium spilled on the contact pins?

Stop your experiment immediately. Disassemble your Connector and clean the contact pins with kim-wipe soaked with 70% ethanol according to the instruction on page 11, and allow to dry.

7. Warranty

This product will be repaired with new or refurbished parts, free of charge, for one (1) year from the date of original purchase in the event of a defect in materials or workmanship.

The product warranty covers failures due to defects in materials or workmanship which occur during normal use. It does NOT cover damage incurred during shipment or problems which are caused by products not supplied by Alpha MED Scientific. In addition, this warranty does not cover problems resulting from alteration, accident, misuse, neglect, faulty installation, maladjustment of user controls, improper maintenance, modifications or service by anyone other than AMS or damage attributable to acts of God.

8. Specifications

Connector unit

MED Probe securing mechanism	Slide in
Out put	20-pin MDR system connector
Material	Aluminum (Gold for contact pins)
Weight	385 g (Bottom unit with a Top Unit)
Dimensions	W130 x L80 x H30 (mm)

MED Connector Cable

Plug	20-pin MDR
Plug cover	Metal
Length	2 m

Specifications may not be satisfied depending upon the type of computer or operating environments used. Only for use in animal studies research. Specifications and external appearance are subject to change without notice.

April 5, 2021



Alpha MED Scientific Inc.

Saito Bio-Incubator 209, 7-7-15, Saito-asagi,
Ibaraki, Osaka 567-0085, Japan

Phone: +81-72-648-7973 FAX:+81-72-648-7974
<http://www.med64.com> support@med64.com

Manufactured by **Alpha MED Scientific Inc.**

©2021 Alpha MED Scientific Inc.